

NCED G.F Energy saving twin circulating pumps with flanges



Construction

Energy saving variable speed circulating pump driven by a permanent magnet synchronous motor (pm) controlled by on board inverter.

Applications

Heating, conditioning, circulating systems.
For civil and industrial applications.

Operating conditions

- Liquid temperature from -10 °C to +110 °C
- Ambient temperature from 0 °C to +40 °C
- Maximum permissible working pressure: 6/10 bar
- Storage: -20°C/+70°C max. relative humidity 95% at 40 °C
- Certifications: in conformity with CE requirements
- Sound pressure ≤ 54 dB (A).
 - Minimum suction pressure: - 0,5 bar at 50 °C.
 - 0,8 bar at 80 °C.
 - 1,4 bar at 110 °C.
- Maximum glycol quantity: 20%.
- EMC according to: EN 55014-1, EN 55014-2
EN 61000-3-2, EN 61000-3-2.
- Connections: Flanges according to PN 6/10, EN 1092-2, DN 40, 50, 65, 80, 100.
- The benchmark for most efficient circulators is EEI ≤ 0,20.

Designation

NCE D G 40 F - 120 / 250

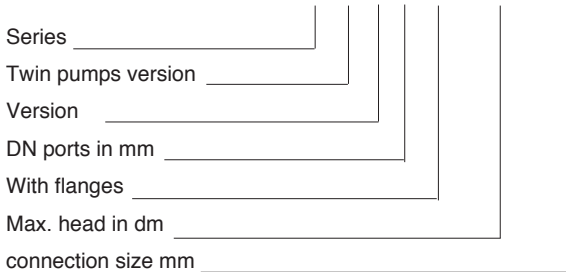

Motor

Synchronous motor with permanent magnet.

- Motor: variable speed
- Standard voltage: single-phase 230 V (-10%;+6%)
- Frequency: 50 Hz
- Protection: IP 44
- Insulation class: H
- Overload protection (integrated).
- Cable: phases and neutral.
- Constructed in accordance with: EN 60335-1, EN 60335-2-51.

Features

Smart pump

NCED G.F adapt its functions to the system: the circulator measures the pressure and the flow and adjusts the speed to the selected pressure.

Easy use

There are different operating modes selectable from the control panel.

Operation

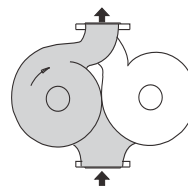

Single operation

Operation of a single pump chosen by the customer, with the second pump on stand-by

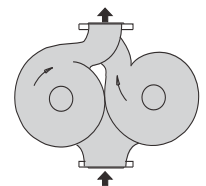

Double operation

Operation in parallel of the two pumps

Operating modes



Automatic mode

(factory setting):

In this mode the pump automatically sets the operating pressure, depending on the hydraulic system. This mode is recommended in most systems.



Proportional pressure mode:

The circulator changes the pressure proportionally to the current flow. The pressure value can be adjusted with the + and - buttons.



Constant pressure mode:

The circulator maintains the pressure constant when the reference flow changes. The pressure value can be adjusted with the + and - buttons.



Fixed speed mode:

The circulator works with constant curve and the curve could be changed using + e - buttons.

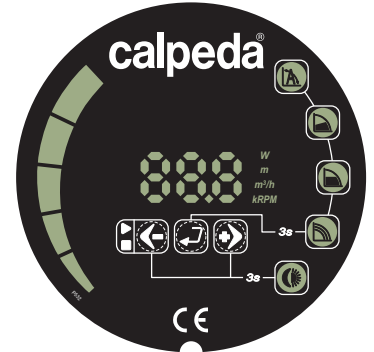

Operating mode-control panel

NCED G.F could works in:

- automatic mode
- proportional pressure mode
- constant pressure mode
- fixed speed mode
- night mode

The night mode could be selected with any operating mode.

Coverage chart

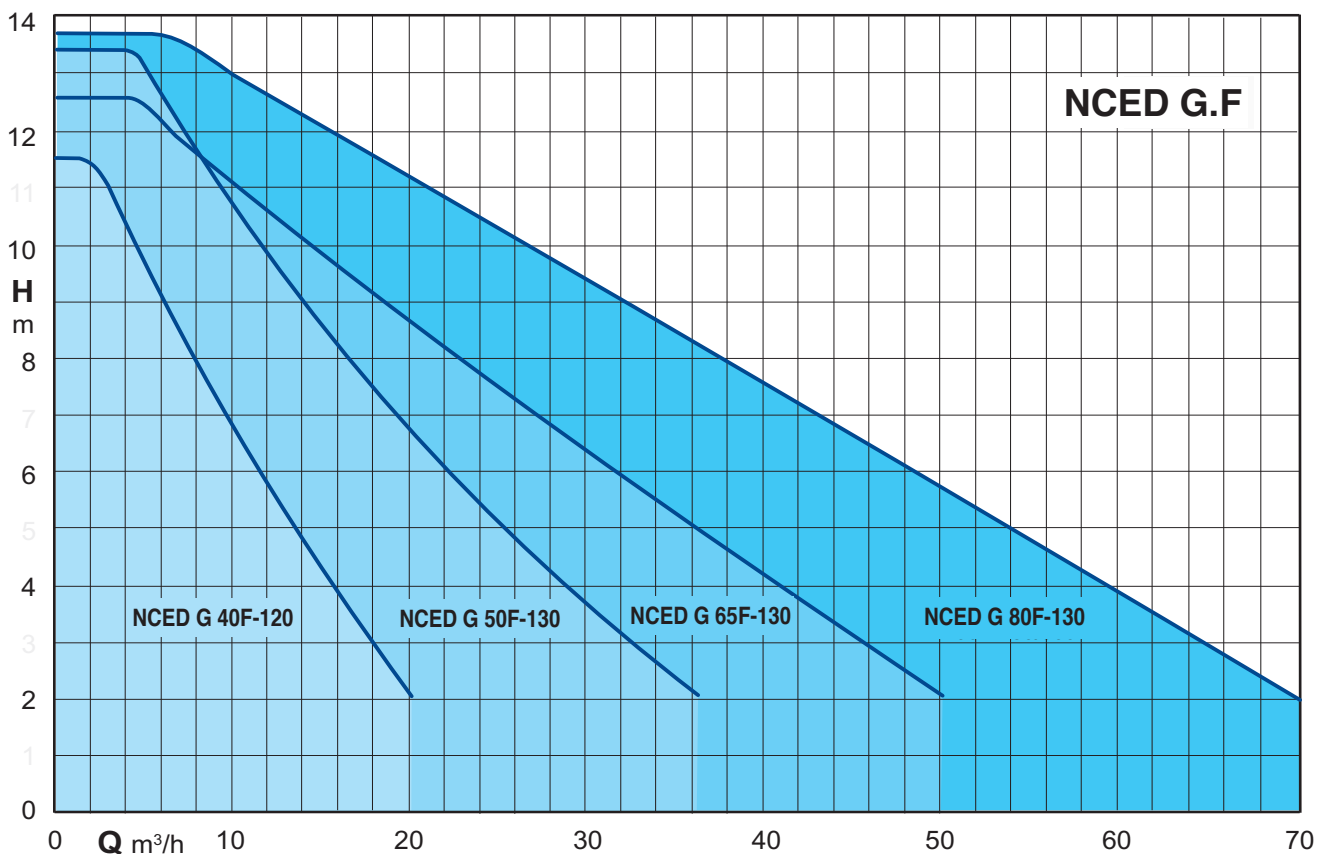

Characteristic curves

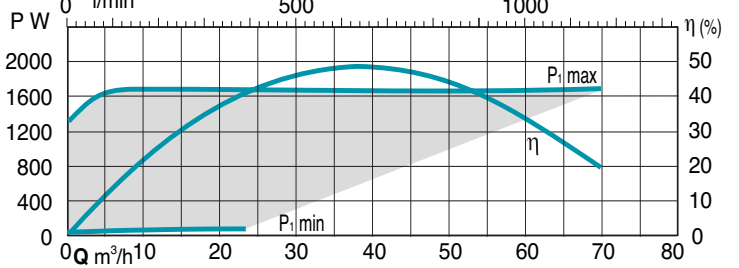
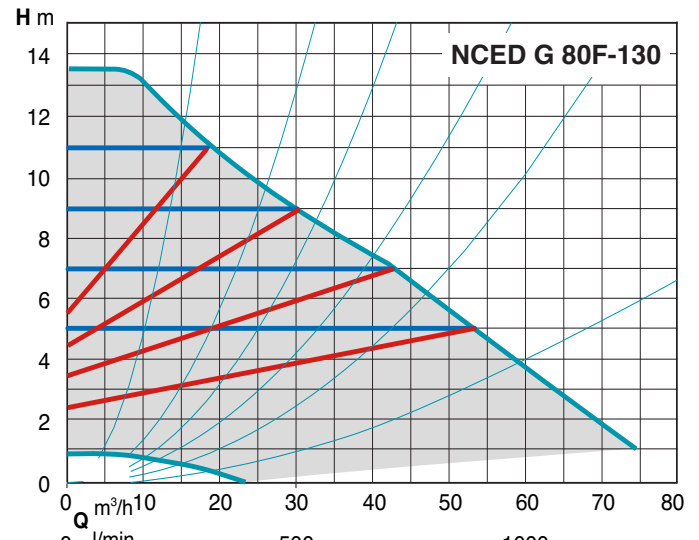
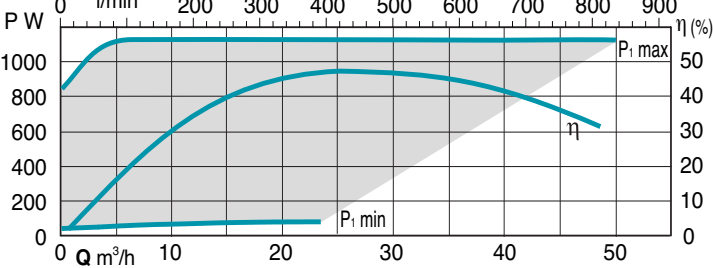
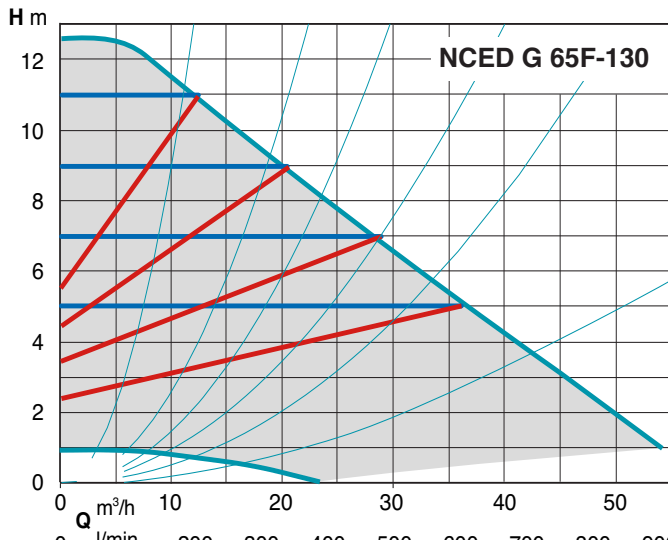
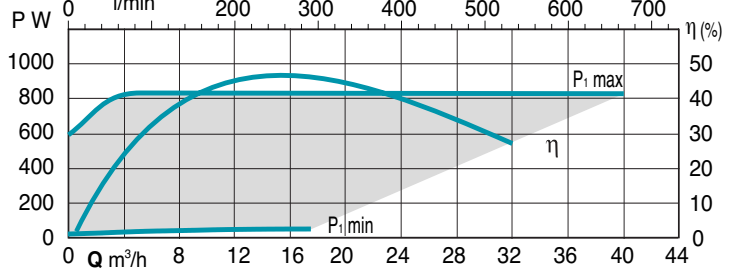
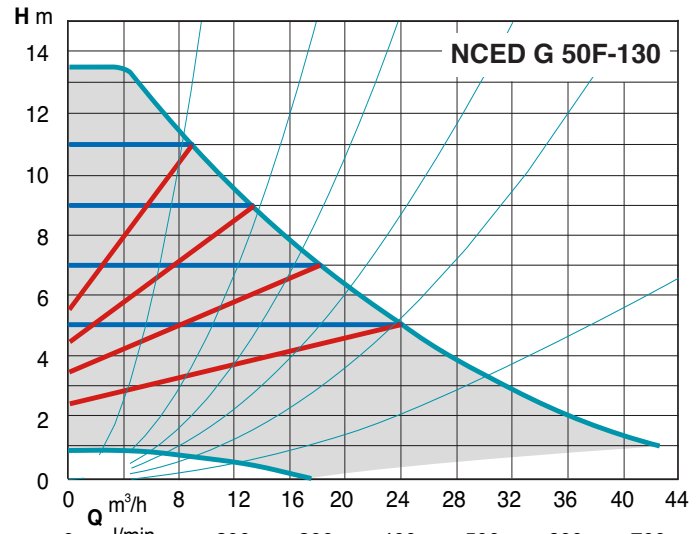
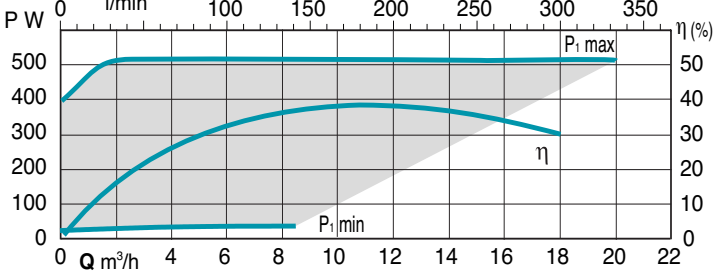
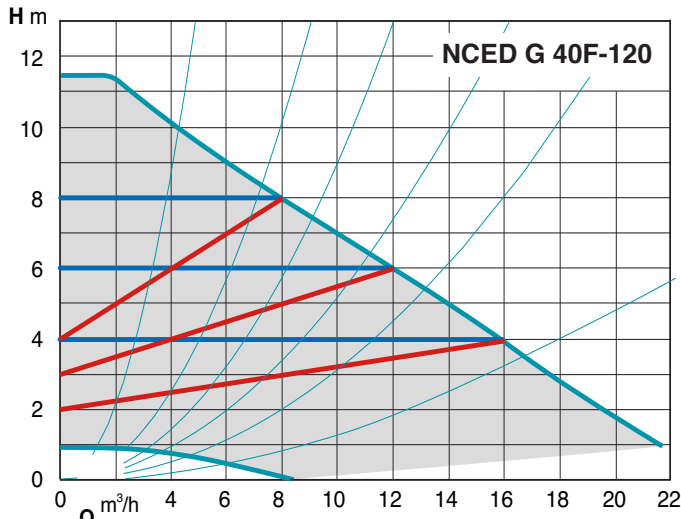

Materials

Component	Pos.	Material
Pump casing	1	Cast iron GJL 200 EN 1561
Impeller	2	Stainless steel
Shaft	3	Stainless steel
Bearings	4	Carbon
Thrust bearing	5	Steel
Rotor	6	Stainless steel jacket
Winding	7	Copper wire
Electronic card	8	-
Gasket	9	EPDM

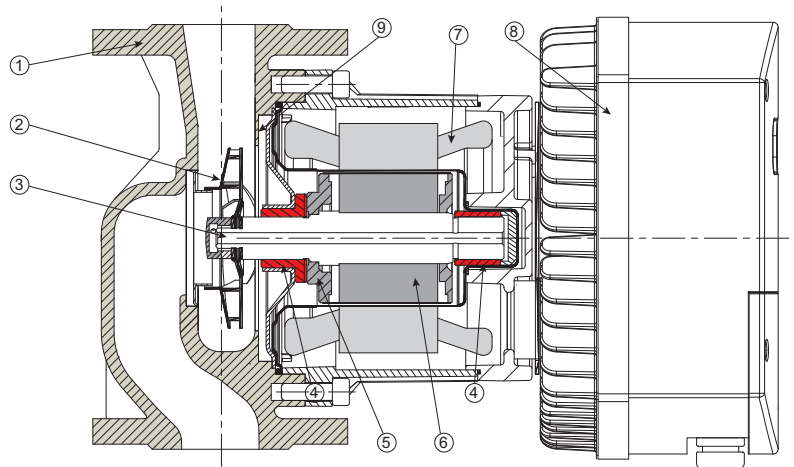

Examples of installations

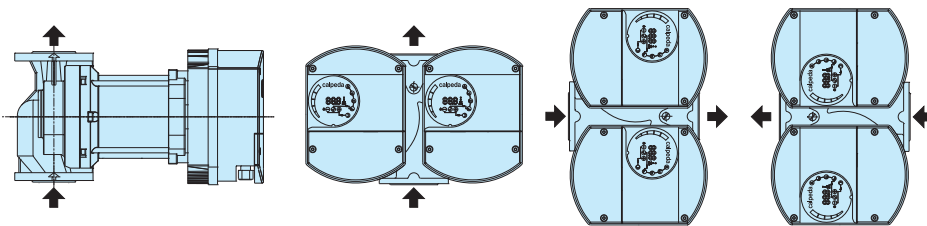

Dimensions and weights

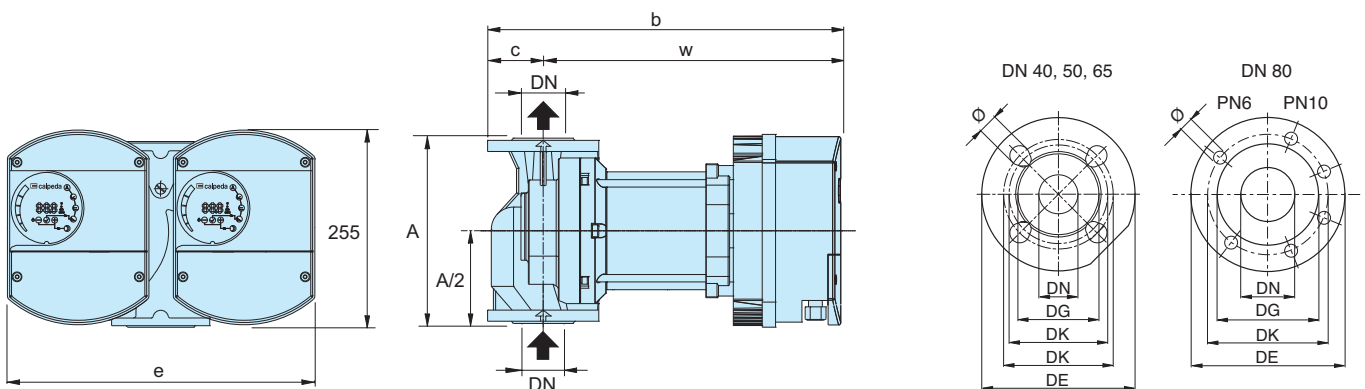

TYPE	DN	H m	Q m ³ /h	1~ 230 V		P ₁		mm					kg
				A min	A max	W min	W max	A	b	c	w	e	
NCED G 40F-120/250	40	12	25	0,18	2,2	20	500	250	386	65	321	403	47
NCED G 50F-130/280	50	13	39	0,23	3,5	26	800	280	425	70	355	403	60
NCED G 65F-130/340	65	13	65	0,33	4,8	38	1100	340	449	80	369	452	63
NCED G 80F-130/360	80	13	78	0,39	6,9	45	1600	360	503	100	403	462	81

DN	DE	DK	DG	holes	
				N.	Ø
40	150	100/110	80	4	14/19
50	165	110/125	90	4	14/19
65	185	130/145	110	4	14/19
80 - PN6	200	150	128	4	19
80 - PN10	200	160	128	8	19
100 - PN6	220	170	-	4	19
100 - PN10	220	180	-	8	19