



### Designation

NCE PS 25 - 60 / 180

Series \_\_\_\_\_  
 Version for sanitary hot water \_\_\_\_\_  
 DN ports in mm \_\_\_\_\_  
 Max. head in dm \_\_\_\_\_  
 connection size mm \_\_\_\_\_

### Construction

Energy saving variable speed circulating pump driven by a permanent magnet synchronous motor (pm) controlled by on board inverter. Bronze pump casing.

### Applications

Sanitary hot water systems.

### Operating conditions

- Liquid temperature from +5 °C to +65 °C
- Ambient temperature from 0 °C to +40 °C
- Maximum permissible working pressure: 10 bar
- Storage: -20°C/+70°C max. relative humidity 95% at 40 °C
- Certifications: in conformity with CE requirements
- Sound pressure  $\leq$  38 dB (A).
- Minimum suction pressure: - 0,05 bar at 75 °C  
- 0,28 bar a 90 °C.
- Maximum glycol quantity: 20%.
- EMC according to: EN 55014-1, EN 55014-2  
EN 61000-3-2, EN 61000-3-2.
- Connections: threaded ports ISO 228: G 1, G 1 1/4, G 1 1/2, G 2.

### Motor

Synchronous motor with permanent magnet.

- Motor: variable speed
- Standard voltage: single-phase 230 V (-10%;+6%)
- Frequency: 50 Hz
- Protection: IP 44
- Insulation class: F
- Overload protection (integrated).
- Cable: phases and neutral.
- Constructed in accordance with: EN 60335-1, EN 60335-2-51.

### Special features on request

The NCE PR version is equipped with an additional module that allows to control the pump with an analog signal 0-10V. Brass unions.

## Features

### Easy adjustment

The adjustment is simple and intuitive thanks to the LED indicator.

### Easy use

3 proportional curves and 3 fixed speed curves are available and selectable by the button.

## Operating modes

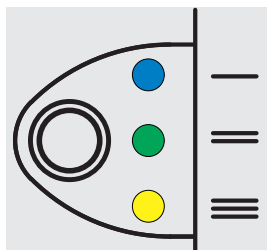

### Operating functions - control buttons.

NCE PS circulator could work:

- with proportional pressure curves
- with fixed speed curves



### PROPORTIONAL CURVE PROGRAMMING $\Delta p-v$

- (P1 BLUE LED blinking light)
- (P2 GREEN LED blinking light)
- (P3 YELLOW LED blinking light)

Push repeatedly the button to select the proportional curve. The color changes depending on the selected curve. This operating mode guarantees the maximum energy efficiency.



### FIXED SPEED CURVE PROGRAMMING

- (I BLUE LED light)
- (II GREEN LED light)
- (III YELLOW LED light)

If you push the button for 5 seconds the pump adopt the fixed speed curve. The color changes depending on the selected curve. (to replace standard 3-speed circulators).

## Coverage chart

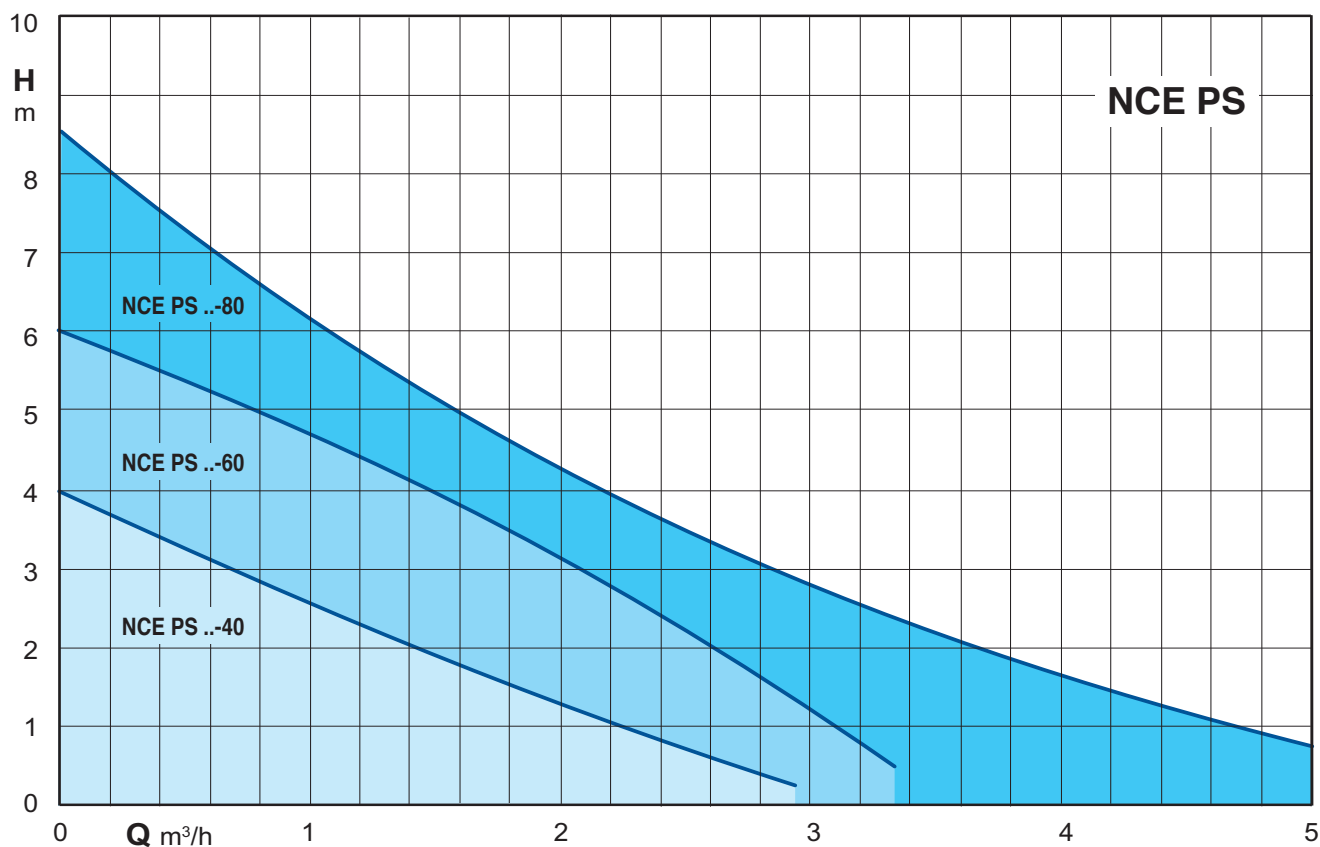

## Characteristic curves

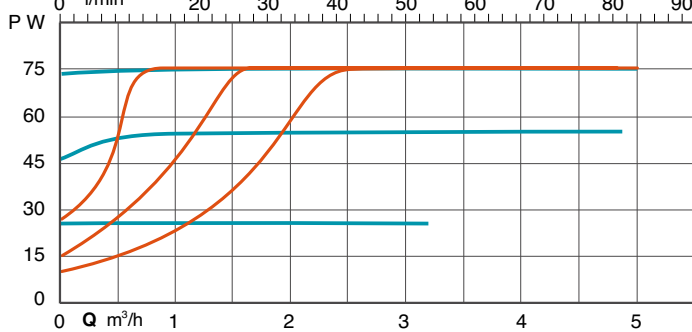
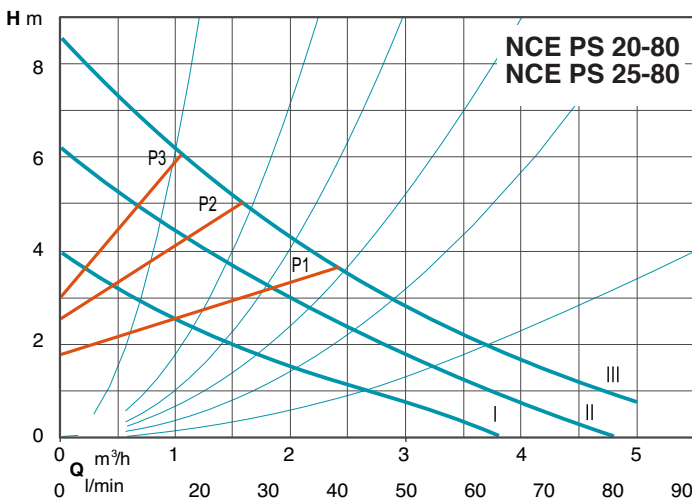
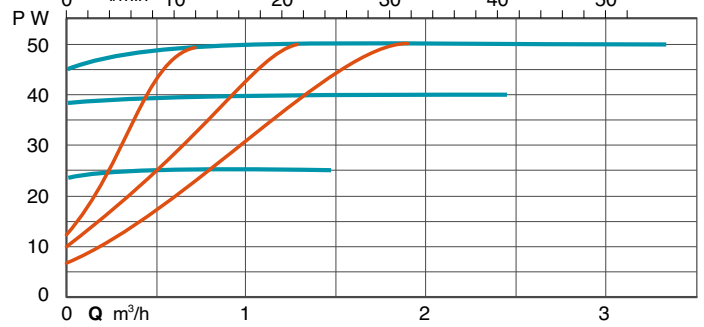
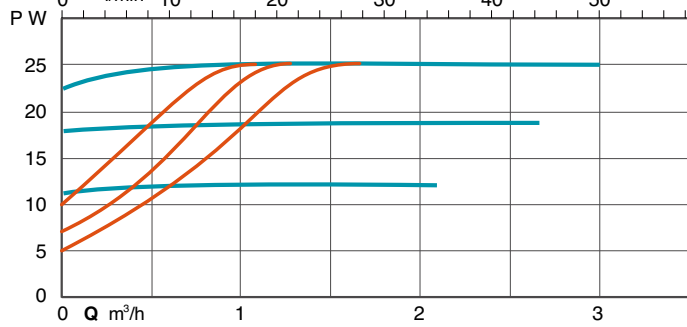
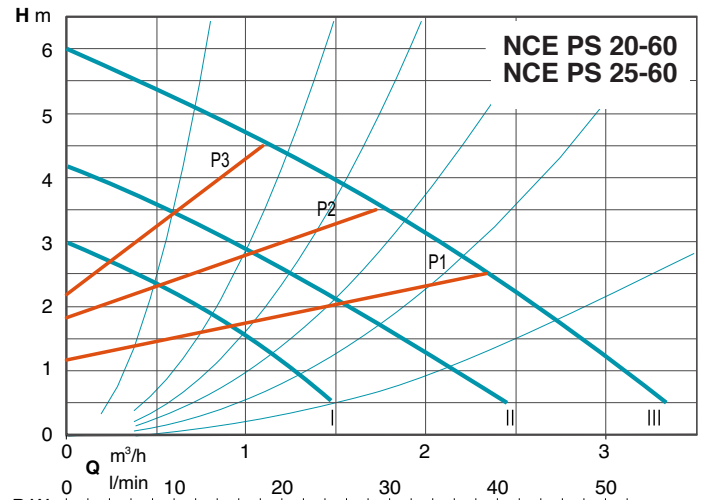
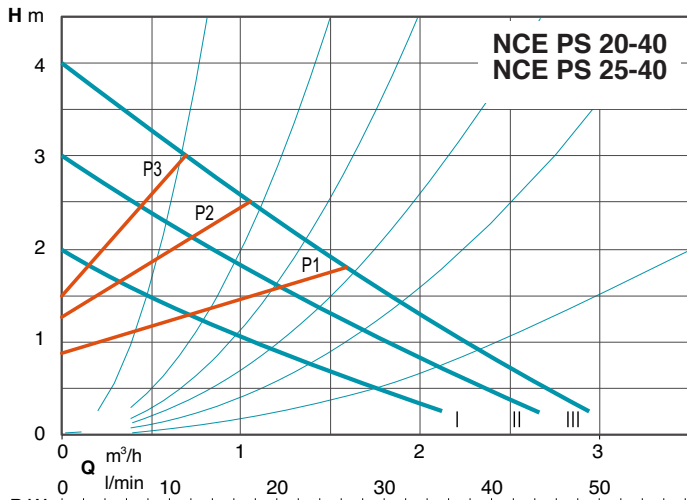

### Materials

Component	Pos.	Material
Pump casing	1	Brass
Impeller	2	Composite
Shaft	3	Ceramic
Bearings	4	Carbon
Thrust bearing	5	Ceramic
Rotor	6	Stainless steel jacket
Winding	7	Copper wire
Electronic card	8	-
Gasket	9	EPDM

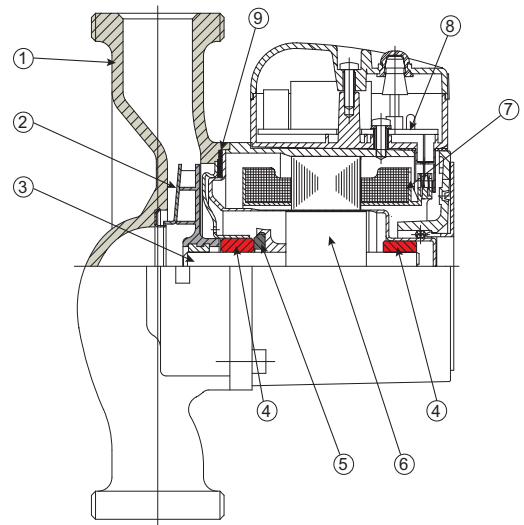

### Examples of installations

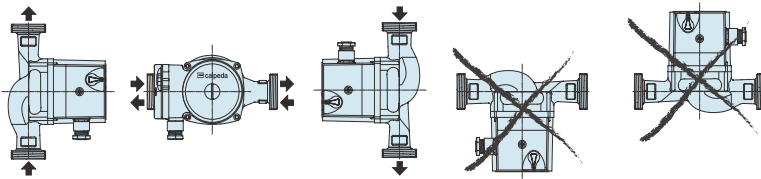

### Dimensions and weights

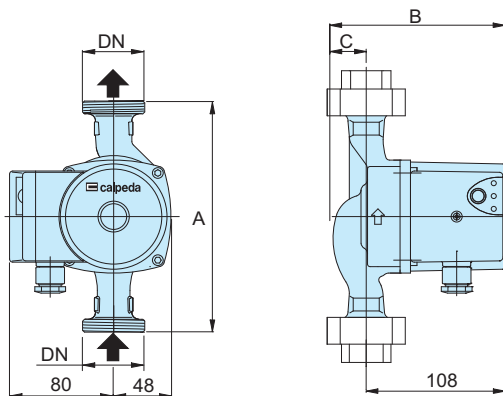

TYPE	DN	H m	Q m <sup>3</sup> /h	1~ 230 V		P1 W max	mm A	kg
				A min	A max			
NCE PS 20-40/130	G 1 1/4	4	2,6	0,05	0,2	25	130	2,1
NCE PS 25-40/130	G 1 1/2							2,2
NCE PS 20-60/130	G 1 1/4	6	3,7	0,05	0,4	50	130	2,1
NCE PS 25-60/130	G 1 1/2							2,2
NCE PS 20-80/130	G 1 1/4	8	4,5	0,05	0,6	75	130	2,1
NCE PS 25-80/130	G 1 1/2							2,2

### Unions (on request)

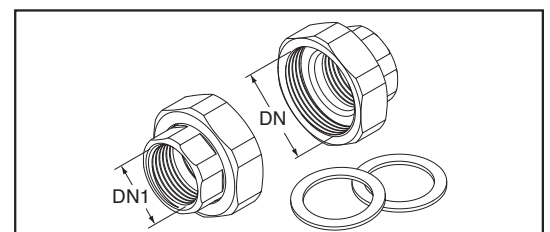

TYPE	DN	DN1
KIT G 1 - G 1/2 (NCE . 15..)	G 1	G 1/2
KIT G 1 1/4 - G 3/4 (NCE . 20..)	G 1 1/4	G 3/4
KIT G 1 1/2 - G 1 (NCE . 25..)	G 1 1/2	G 1
KIT G 2 - G 1 1/4 (NCE . 32..)	G 2	G 1 1/4